

Inlet air temperature	[°C]	0.00	Temperatura parowania	[°C]	-8.00
DT	[K]	8.00	Refrigerant*		R404A
Minimalna ilość chłodziw w komorze		0	Wysokość nad poziomem morza	[m]	0.0

Wymiennik ciepła	Aluminium fin	Obudowa	Standard
Zasilanie wentylatora	Standard	Wentylatory	AC motors
Odtajanie	Absent		

Selected model: 1 x GCE 254G6

Capacity	[kW]	4.61	Margin	[%]	0.0
DT	[K]	8.0	Tot. air flow	[m³/h]	3390.0
Tot. Pres.S.Lev.	[dB(A) @[m]]	42 (5m)			

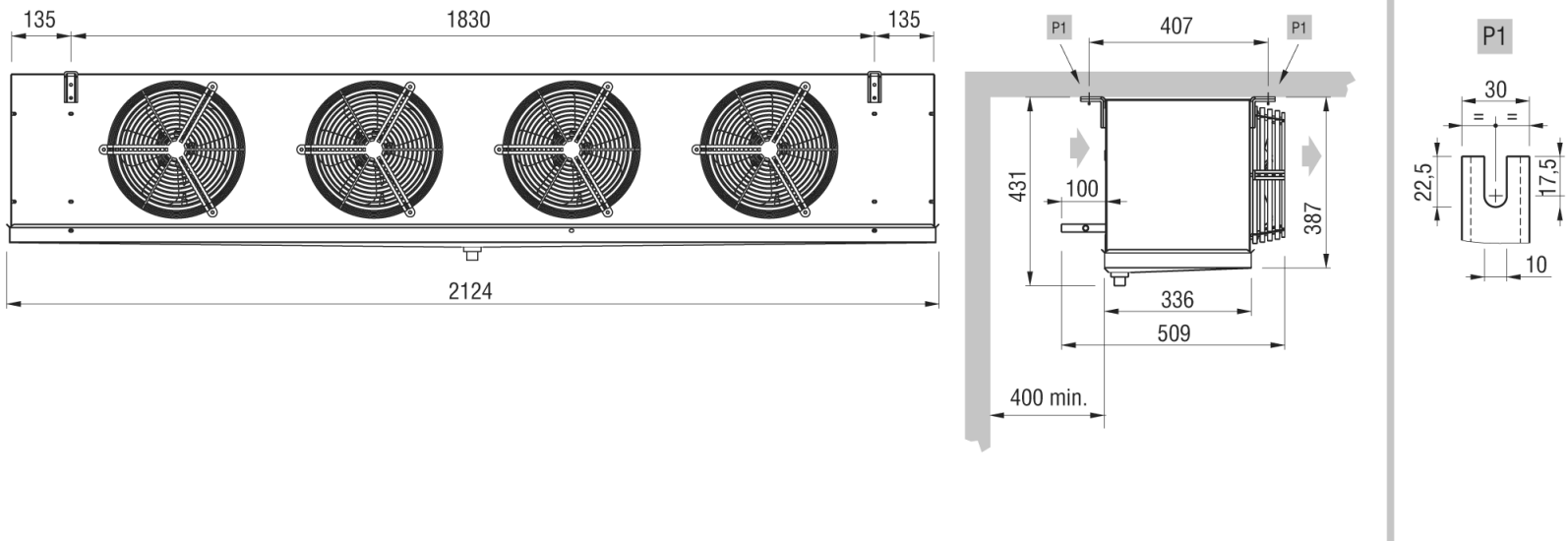

Weight	kg	35.500	PED Category		Cat I
			Design Pressure PS	[bar]	30
Internal surface	m²	2.20	External surface	m²	19.88
Inlet connection		12 mm	Output connection		22 mm
Total circuit capacity	dm³	3.2	Fin spacing	mm	6
Drain connection		1" GAS			

Fan Motors	n.	4	Diameter	mm	250
Air flow	m³/h	3390	Air throw	m	14.0
Feed	V	230/1/50-60	Rotation speed	rpm	1300
Fan Motor	A	2.72	Absorbed power	W	380
Pres.S.Lev. 5 m.	dB(A)	42			



* The safety requirements for the use of refrigerants must comply with the provisions of the EN378 standards and the safety data sheets of each fluid used. The risk assessment for the use of A2L mid-flammable refrigerants shall be conducted by the user based on site requirements

We shall not be liable for the performance and the quality of sold products, if fitted or connected fan motor speed regulation or control systems are different from the ones proposed or installed by us.